

REVISION HISTORY			
REV	DESCRIPTION	DATE	APPROVED

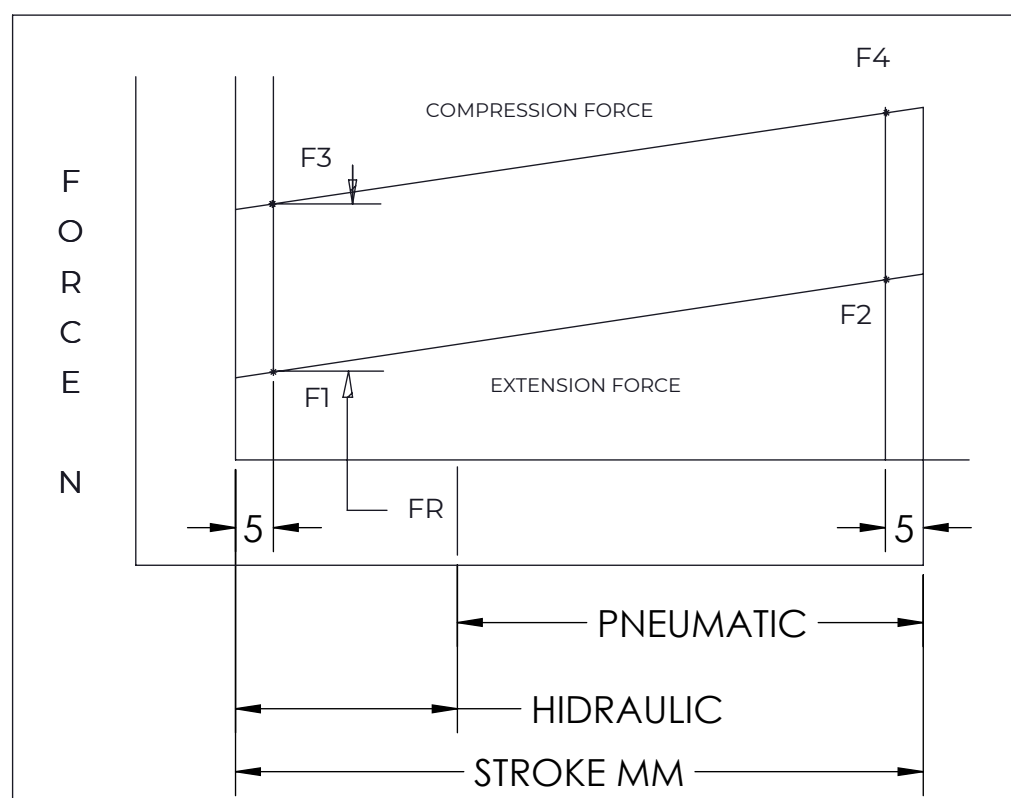
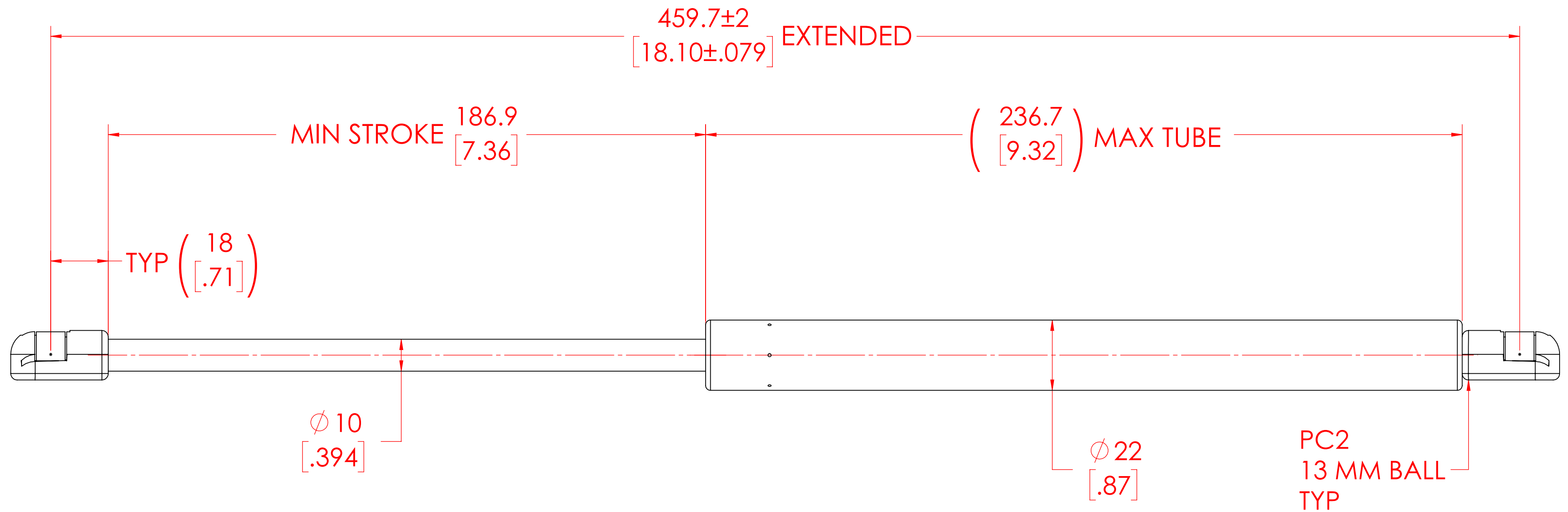

FORCES (STATICALLY MEASURED)	
F1	F2
75 LBS (334 N) +10% -5%	-

NOTES:

- 1) MATERIAL: CYLINDER - STEEL, BLACK PAINT / ROD - STEEL BLACK NITRIDE.
- 2) OPERATING TEMPERATURE: -40°C TO +80°C.
- 3) STANDARD PART IDENTIFICATION TO INCLUDE PART NUMBER, DATE CODE AND WARNING MESSAGE. LABEL NOT TO BE REMOVED
- 4) GAS SPRING IS SUGGESTED TO BE MOUNTED SHAFT DOWN (ROD DOWN) FOR MAXIMUM PERFORMANCE.
- 5) END FITTINGS TO BE ORIENTED AS SHOWN ±5°.
- 6) GAS SPRINGS WILL BE SEALED IN CLEAR PLASTIC BAGS TO AVOID DAMAGE, DUST, OR OTHER FOREIGN OBJECTS.
- 7) GAS SPRING TO BE ASSEMBLED WITH END FITTINGS COMPLETELY FASTENED.
- 8) GREASE TO BE INCLUDED INSIDE THE BALL SOCKET OF THE END FITTINGS

NORMONT		NAME	DATE
		MABR	01/18/2024
THIS DOCUMENT AND ITS CONTENTS ARE THE PROPERTY OF NORMONT THIS DOCUMENT CONTAINS CONFIDENTIAL PROPRIETARY INFORMATION. THE REPRODUCTION, DISTRIBUTION, UTILISATION OR THE COMMUNICATION OF THIS DOCUMENT OR ANY PART THEREOF, WITHOUT EXPRESS AUTHORISATION IS STRICTLY FORBIDDEN.		PART No.	NSG1825L75PC2
		TITLE	GAS SPRING
REMOVE ALL BURRS AND BREAK ALL SHARP EDGES	ALL DIMENSIONS ARE DUAL UNLESS OTHERWISE SPECIFIED	TOLERANCES	SCALE
		XX ± 0.060	THIRD ANGLE PROJECTION
		X.XX ± 0.030	
		X.XXX ± 0.010	
		ANGLES ± 1°	SIZE
HOLES ± 0.005	C		
		SHEET 1 OF 1	