

REVISION HISTORY			
REV	DESCRIPTION	DATE	APPROVED
1			
2			
3			

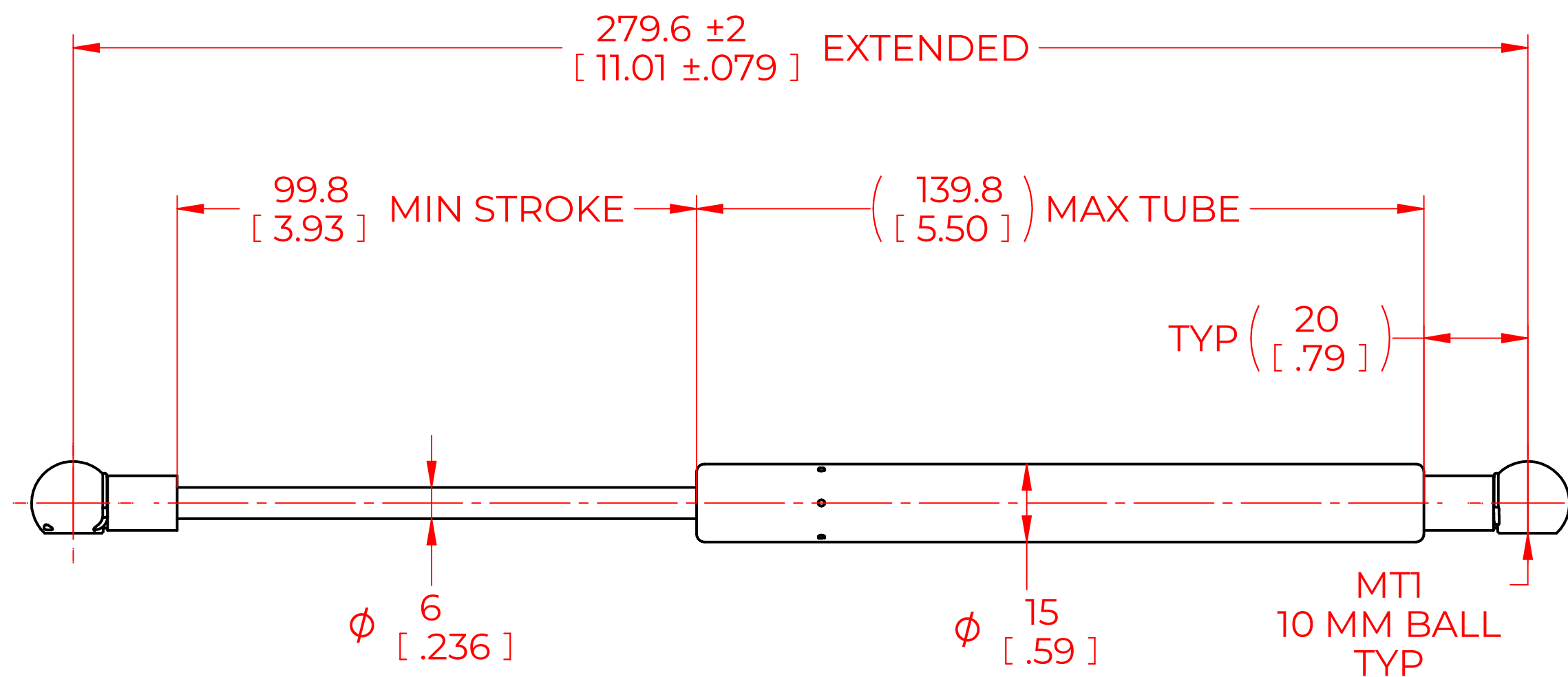

FORCES (STATICALLY MEASURED)	
F1	(F2)
70 LBS (311 N) +10% -5%	

NOTES:

- 1) MATERIAL: CYLINDER - HEAVY GAUGE STEEL, BLACK PAINT. ROD - HARDENED STEEL BLACK NITRIDE.
- 2) OPERATING TEMPERATURE: -40°C TO +80°C.
- 3) STANDARD LABEL TO INCLUDE PART NUMBER, DATE CODE AND WARNING MESSAGE. LABEL NOT TO BE REMOVED.
- 4) GAS SPRING NOT TO BE CHANGED OR MODIFIED FROM ITS ORIGINAL MANUFACTURED INTENT.
- 5) GAS SPRING IS SUGGESTED TO BE MOUNTED SHAFT DOWN (ROD DOWN) FOR MAXIMUM PERFORMANCE.
- 6) CONNECTORS TO BE ORIENTED AS SHOWN ±5°.
- 7) GAS SPRINGS WILL BE SEALED IN CLEAR PLASTIC BAGS TO AVOID DAMAGE, DUST, OR OTHER FOREIGN OBJECTS.
- 8) GAS SPRING TO BE ASSEMBLED WITH END FITINGS COMPLETELY FASTENED.
- 9) GAS SPRINGS ARE NOT TO BE OPENED.
- 10) GREASE TO BE INCLUDED INSIDE THE BALL SOCKET OF THE END FITTINGS.

NORMONT	DRAWN	NAME	DATE
	CHECKED	CSH	06/20/2023
	PART No. NSG1085S70MT1		REV
THIS DOCUMENT AND ITS CONTENTS ARE THE PROPERTY OF NORMONT. THIS DOCUMENT CONTAINS CONFIDENTIAL PROPRIETARY INFORMATION. THE REPRODUCTION, DISTRIBUTION, UTILISATION OR THE COMMUNICATION OF THIS DOCUMENT OR ANY PART THEREOF, WITHOUT EXPRESS AUTHORISATION IS STRICTLY FORBIDDEN.	TITLE		SCALE
	GAS SPRING		1:1
	TOLERANCES	THIRD ANGLE PROJECTION	SIZE
	X.X	± 0.060	
REMOVE ALL BURRS AND BREAK ALL SHARP EDGES	ALL DIMENSIONS ARE DUAL UNLESS OTHERWISE SPECIFIED	X.XX	± 0.030
		X.XXX	± 0.010
		ANGLES	± 1°
		HOLES	± 0.005
		SHEET 1 OF 1	