

REVISION HISTORY			
REV	DESCRIPTION	DATE	APPROVED

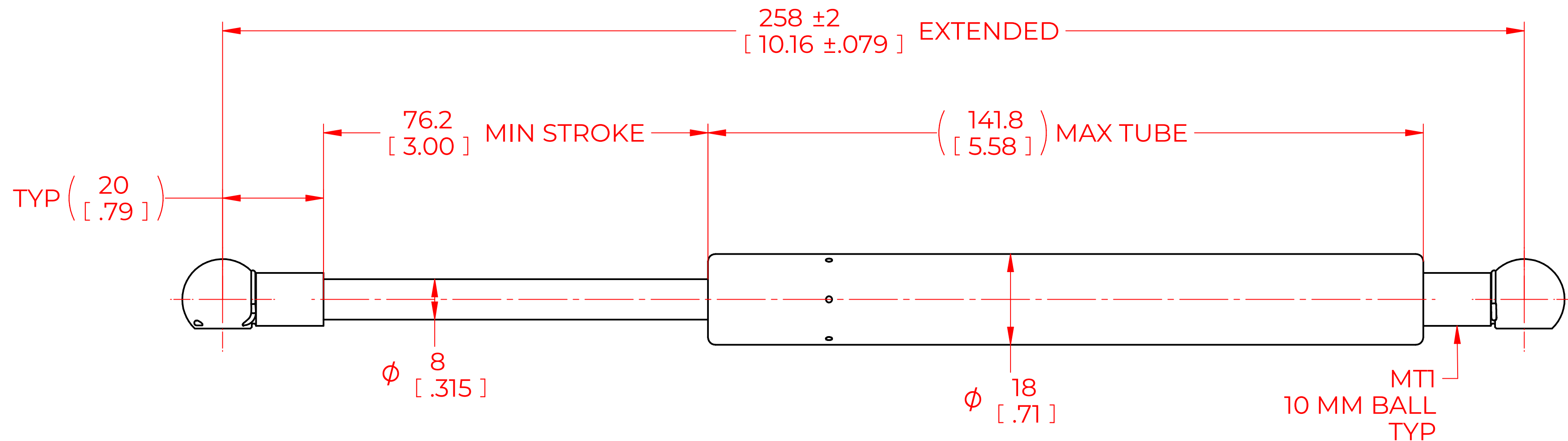

FORCES (STATICALLY MEASURED)	
F1	(F2)
150 LBS (667 N) <sup>+7%</sup> <sub>-5%</sub>	-

**NOTES:**

- 1) MATERIAL: CYLINDER - STEEL, BLACK PAINT / ROD - STEEL BLACK NITRIDE.
- 2) OPERATING TEMPERATURE: -40°C TO +80°C.
- 3) STANDARD PART IDENTIFICATION TO INCLUDE PART NUMBER, DATE CODE AND WARNING MESSAGE. LABEL NOT TO BE REMOVED
- 4) GAS SPRING IS SUGGESTED TO BE MOUNTED SHAFT DOWN (ROD DOWN) FOR MAXIMUM PERFORMANCE.
- 5) END FITTINGS TO BE ORIENTED AS SHOWN ±5°.
- 6) GAS SPRINGS WILL BE SEALED IN CLEAR PLASTIC BAGS TO AVOID DAMAGE, DUST, OR OTHER FOREIGN OBJECTS.
- 7) GAS SPRING TO BE ASSEMBLED WITH END FITTINGS COMPLETELY FASTENED.
- 8) GREASE TO BE INCLUDED INSIDE THE BALL SOCKET OF THE END FITTINGS.

<b>NORMONT</b>	DRAWN	JACN	NAME	JACN	DATE	01/10/2024
	CHECKED					
	PART No.		NSG1000M150MTI		REV	-
THIS DOCUMENT AND ITS CONTENTS ARE THE PROPERTY OF NORMONT THIS DOCUMENT CONTAINS CONFIDENTIAL PROPRIETARY INFORMATION. THE REPRODUCTION, DISTRIBUTION, UTILISATION OR THE COMMUNICATION OF THIS DOCUMENT OR ANY PART THEREOF, WITHOUT EXPRESS AUTHORISATION IS STRICTLY FORBIDDEN.	TITLE		GAS SPRING		SCALE	N.T.S.
	TOLERANCES		THIRD ANGLE PROJECTION		SIZE	C
	X.X	± 0.060				
	X.XX	± 0.030				
X.XXX	± 0.010	ANGLES	± 1°			
REMOVE ALL BURRS AND BREAK ALL SHARP EDGES	ALL DIMENSIONS ARE DUAL UNLESS OTHERWISE SPECIFIED		HOLES	± 0.005	SHEET 1 OF 1	