

REVISION HISTORY			
REV	DESCRIPTION	DATE	APPROVED

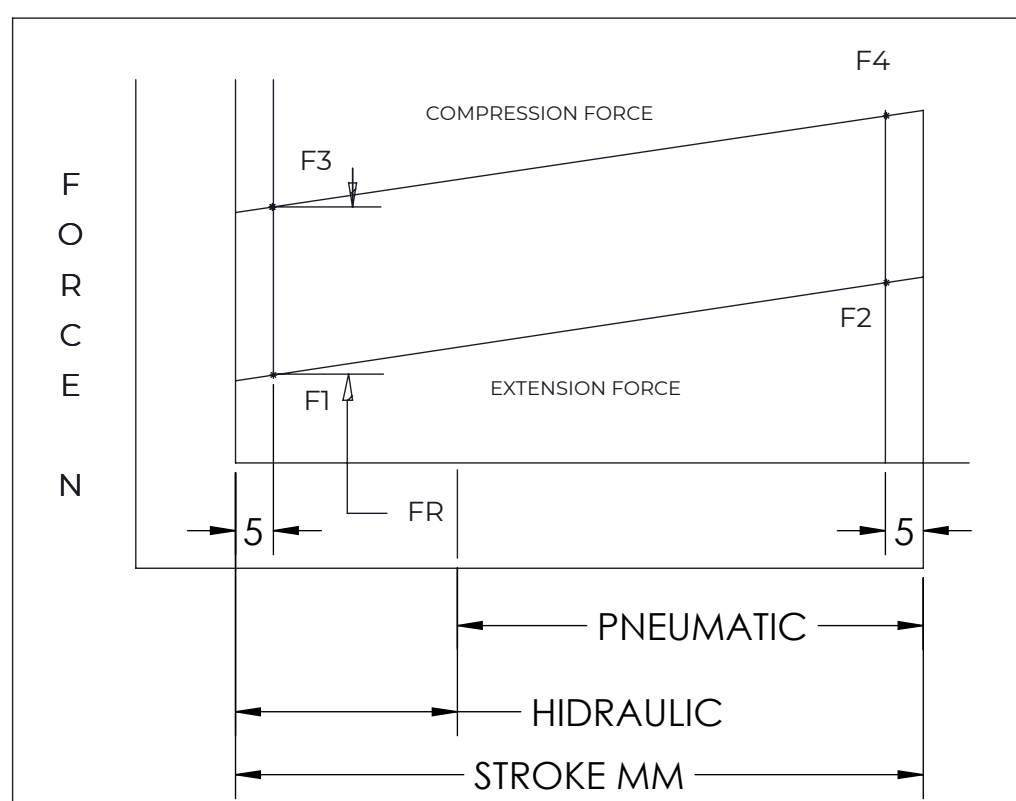
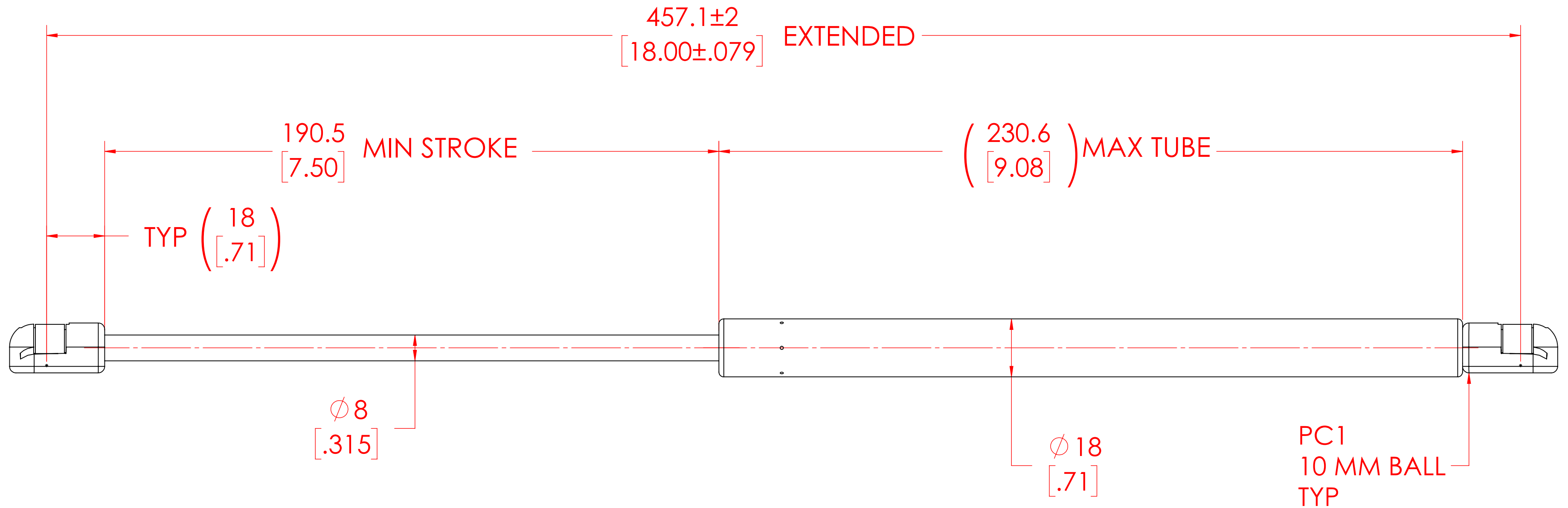

FORCES (STATICALLY MEASURED)	
F1	F2
40 LBS (178 N) +10% -5%	-

- NOTES:**
- 1) MATERIAL: CYLINDER - STEEL, BLACK PAINT / ROD - STEEL BLACK NITRIDE.
 - 2) OPERATING TEMPERATURE: -40°C TO +80°C.
 - 3) STANDARD PART IDENTIFICATION TO INCLUDE PART NUMBER, DATE CODE AND WARNING MESSAGE. LABEL NOT TO BE REMOVED
 - 4) GAS SPRING IS SUGGESTED TO BE MOUNTED SHAFT DOWN (ROD DOWN) FOR MAXIMUM PERFORMANCE.
 - 5) END FITTINGS TO BE ORIENTED AS SHOWN ±5°.
 - 6) GAS SPRINGS WILL BE SEALED IN CLEAR PLASTIC BAGS TO AVOID DAMAGE, DUST, OR OTHER FOREIGN OBJECTS.
 - 7) GAS SPRING TO BE ASSEMBLED WITH END FITTINGS COMPLETELY FASTENED.
 - 8) GREASE TO BE INCLUDED INSIDE THE BALL SOCKET OF THE END FITTINGS

<h1>NORMONT</h1> <p>THIS DOCUMENT AND ITS CONTENTS ARE THE PROPERTY OF NORMONT THIS DOCUMENT CONTAINS CONFIDENTIAL PROPRIETARY INFORMATION. THE REPRODUCTION, DISTRIBUTION, UTILISATION OR THE COMMUNICATION OF THIS DOCUMENT OR ANY PART THEREOF, WITHOUT EXPRESS AUTHORISATION IS STRICTLY FORBIDDEN.</p>	NAME	DATE	
	MABR	01/18/2024	
	PART No. NSG1800M40PC1		
	TITLE GAS SPRING		
<p>REMOVE ALL BURRS AND BREAK ALL SHARP EDGES</p> <p>ALL DIMENSIONS ARE DUAL UNLESS OTHERWISE SPECIFIED</p>	TOLERANCES	SCALE	
	XX ± 0.060		1:1
	X.XX ± 0.030		
	X.XXX ± 0.010		C
	ANGLES ± 1°		
HOLES ± 0.005	SHEET 1 OF 1		