

REVISION HISTORY			
REV	DESCRIPTION	DATE	APPROVED
1	TEMPLATE UPDATED. FORCE TOLERANCE ADDED.	02/01/2024	JACN

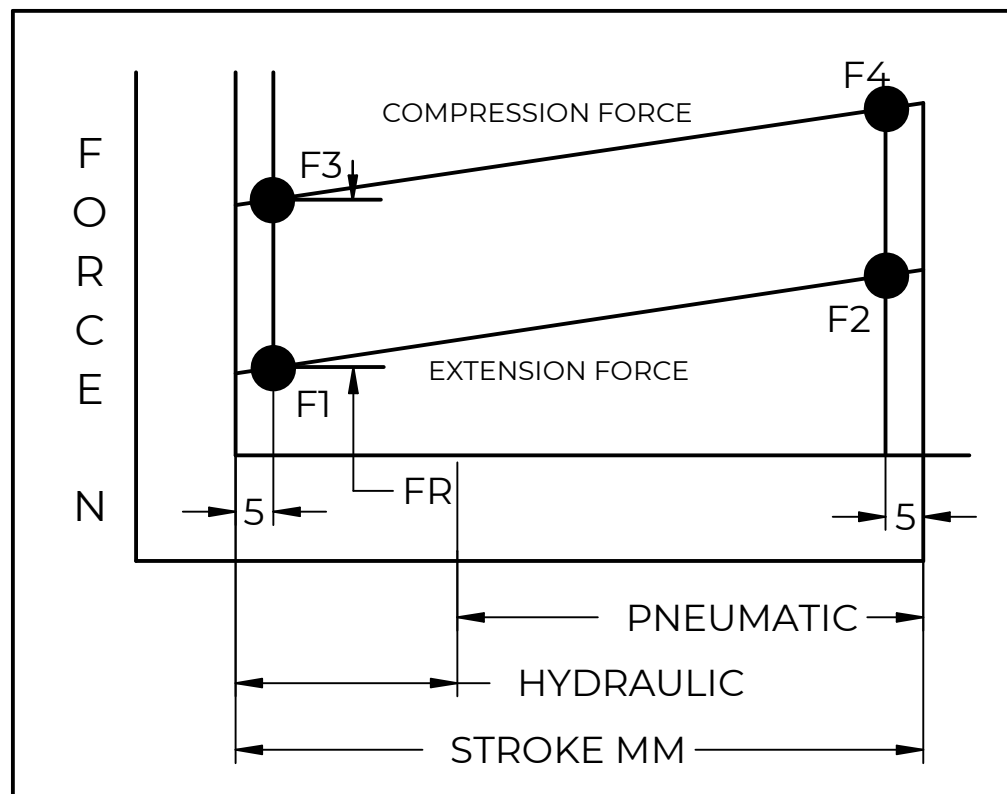
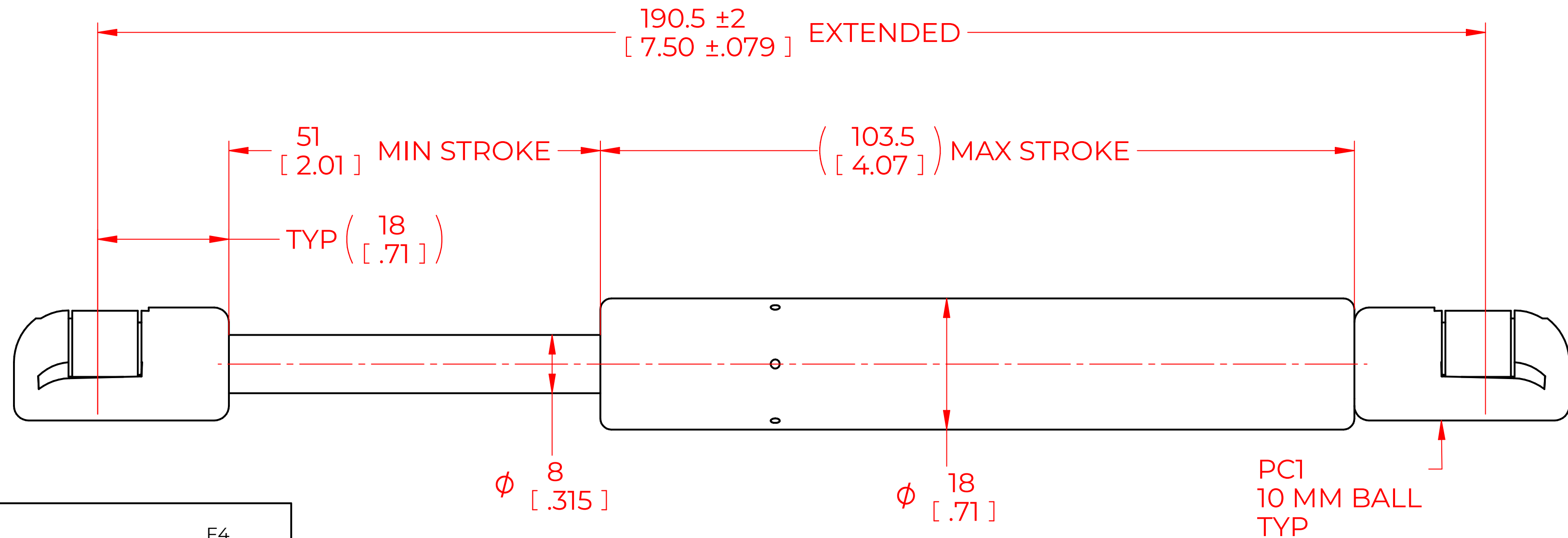

FORCES (STATICALLY MEASURED)	
F1	(F2)
80 LBS (356 N) ^{+10%} _{-5%}	-

NOTES:

- 1) MATERIAL: CYLINDER - STEEL, BLACK PAINT / ROD - STEEL BLACK NITRIDE.
- 2) OPERATING TEMPERATURE: -40°C TO +80°C.
- 3) STANDARD PART IDENTIFICATION TO INCLUDE PART NUMBER, DATE CODE AND WARNING MESSAGE. LABEL NOT TO BE REMOVED.
- 4) GAS SPRING IS SUGGESTED TO BE MOUNTED SHAFT DOWN (ROD DOWN) FOR MAXIMUM PERFORMANCE.
- 5) END FITTINGS TO BE ORIENTED AS SHOWN ±5°.
- 6) GAS SPRINGS WILL BE SEALED IN CLEAR PLASTIC BAGS TO AVOID DAMAGE, DUST, OR OTHER FOREIGN OBJECTS.
- 7) GAS SPRING TO BE ASSEMBLED WITH END FITTINGS COMPLETELY FASTENED.
- 8) GREASE TO BE INCLUDED INSIDE THE BALL SOCKET OF THE END FITTINGS.

NORMONT	DRAWN	NAME	DATE	
	CHECKED	CSH	05/17/2023	
THIS DOCUMENT AND ITS CONTENTS ARE THE PROPERTY OF NORMONT THIS DOCUMENT CONTAINS CONFIDENTIAL PROPRIETARY INFORMATION. THE REPRODUCTION, DISTRIBUTION, UTILISATION OR THE COMMUNICATION OF THIS DOCUMENT OR ANY PART THEREOF, WITHOUT EXPRESS AUTHORISATION IS STRICTLY FORBIDDEN.	PART No. NSG750M80PC1		REV	
	TITLE GAS SPRING			
	TOLERANCES		THIRD ANGLE PROJECTION	SCALE
	X.X	± 0.060		2:1
REMOVE ALL BURRS AND BREAK ALL SHARP EDGES	X.XX	± 0.030		SIZE
	X.XXX	± 0.010		C
	ANGLES	± 1°		
	HOLES	± 0.005	SHEET 1 OF 1	
ALL DIMENSIONS ARE DUAL UNLESS OTHERWISE SPECIFIED				